

Bearing retention and clearances

Bearing retention	90
■ Radial retention	90
■ Axial retention	91
<i>Positioning of single bearing assemblies</i>	91
<i>Positioning of two bearing assemblies</i>	92
■ Axial retention processes	93
Bearing seats	96
■ Bearing tolerances	96
■ Shaft and housing seat tolerances	97
■ Recommended fits	98
■ Value of tolerances and fits	100
■ Geometry and surface conditions of shaft and housing seats	106
Radial clearance of radial contact bearings	109
■ Residual radial clearance : definition, calculation	109
<i>Ratio of interference effect on clearance</i>	109
<i>Residual clearance after fitting: J_{Im}</i>	110
<i>Choice of internal clearance as a function of shaft and housing fits</i>	112
<i>Calculation of residual clearance in operation</i>	112
Axial clearance of angular contact bearings	115
■ Axial preload	115
<i>Axial penetration and prelaod</i>	115
<i>Determining the preload</i>	116
<i>Adjustment</i>	117
■ Theoretical calculation of the variation in the axial clearance of an assembly	117
<i>Modification of clearance on assembly</i>	117
<i>Theoretical calculation of the variation in the axial clearance of an assembly</i>	118

Bearing retention

Radial retention

The bearing rings must be assembled with the mounting elements (shaft and housing) such that they become an integral part of them. The means of connection must prevent any relative movement of the rings on their seat under the radial and axial loads, while maintaining the precision of the bearing, its operating clearance, its limit loads, speed, temperature, etc.

Under the action of the radial load, one of the two rings of a rotating bearing is "rolled" between the rolling elements and its seat, and tends to turn on it. This relative displacement must be prevented to avoid wearing of the seat (bearing hardness: 62 HRC).

■ General rule

The ring that rotates with respect to the load direction must be press fitted on its seat.

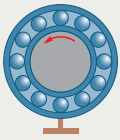
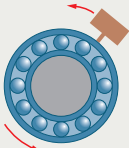
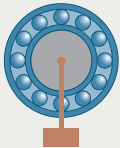
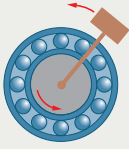
	Analysis of rotation (cases frequency)		Retention principle
Load stationary with respect to the outer ring	Stationary housing and load (95 %)  Rotating inner ring	Rotating housing and load (0.05 %)  Stationary inner ring	Inner ring interference-fitted on shaft
Load stationary with respect to the inner ring	Stationary shaft and load (3 %)  Outer ring rotating	Rotating shaft and load (1.5 %)  Outer ring stationary	Outer ring interference-fitted in the housing

The bearing rings are usually retained with an interference fit. Other methods of retention do exist as: adapter sleeves (see page 139), eccentric locking collars or set screw on inner ring, gluing, etc. The seat fits are chosen from Standard ISO 286 according to the bearing operating criteria.

Axial retention

The bearings secure the axial positioning of the rotating part of a component with respect to the stationary part.

→ Positioning of single bearing assemblies

■ Retention of bearing assemblies requires one bearing to float axially to prevent stresses due to thermal expansion

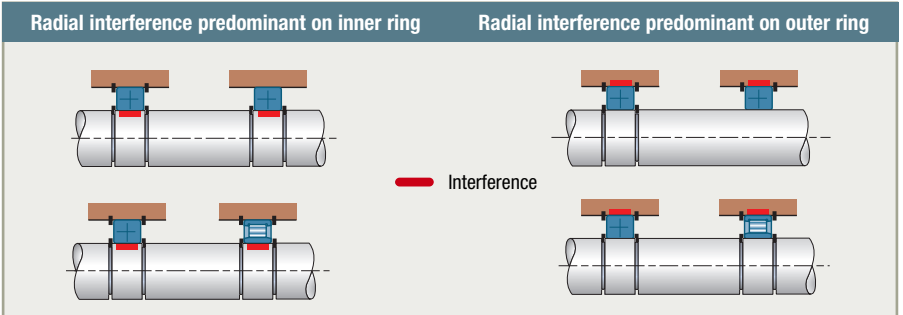

Stationary bearing F

- ▶ the bearing must be positioned by the axial retention of the inner ring and the outer ring
- ▶ possible bearing types

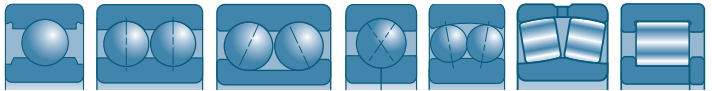

Floating bearing L

- ▶ only the tight fitted ring is axially held, the other is loose
- ▶ possible bearing types

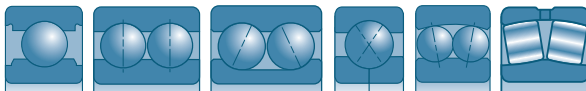

Floating bearing L1

- ▶ with cylindrical roller bearings type N or NU, in which axial mobility is ensured by the bearing itself, the two bearing rings are retained
- ▶ possible bearing types

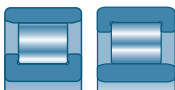

■ Fixed assembly with two bearings

The fixed assembly may be made up of two associated bearings, depending on the assembly specifications.

Bearing retention (continued)

→ Positioning of two bearing assemblies

■ The principle of this assembly is to have one assembly limiting axial displacement of the shaft in one axial direction, while the other assembly limits it in the opposite direction.

This implies that one of the bearing rings must be free to move axially on its seat to permit assembly. The operating axial displacement then depends on the axial adjustment of the relative position of the inner rings with respect to the outer rings.

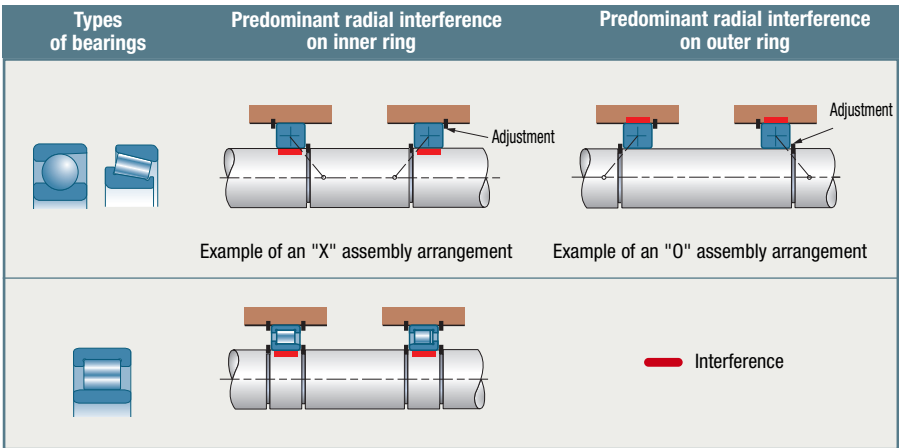

■ Radial contact bearings

This type of assembly can be used with the various types of radial contact bearings: ball bearings, cylindrical roller bearings, self-aligning and spherical bearings. A minimum axial displacement must apply, which varies according to the types of assembly.

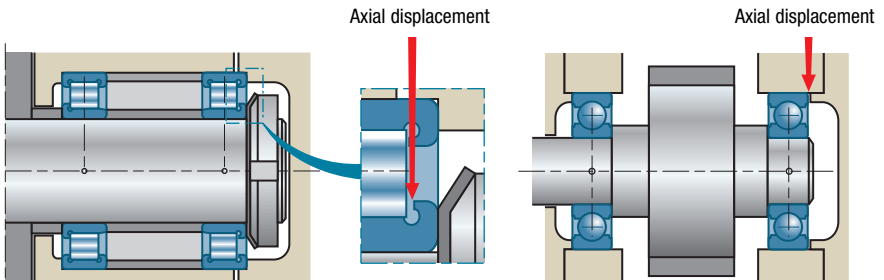

■ Angular contact bearings

Angular contact bearings get their rigidity through their fitting. They have to be adjusted to secure the relative positioning and the operating clearance.

Two types of assembly are possible:

Face-to-face assembly (O): the points of load application are located outside the bearings.

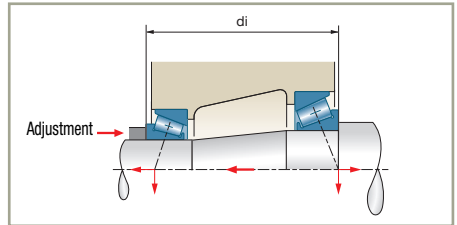

Back-to-back assembly (X): the points of load application are located between the bearings.

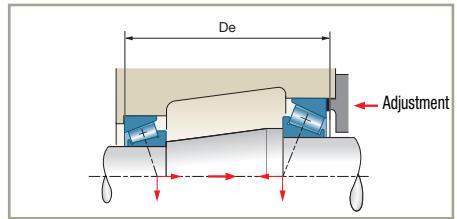

Axial retention processes

■ Inner ring

Nut and washer

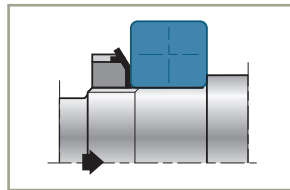

Cylindrical seat.
Tight fit against shoulder.

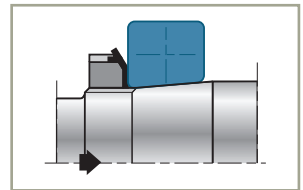

Tapered seat, therefore bearing with tapered bore.
Preferential direction of axial thrust (→).

Snap ring

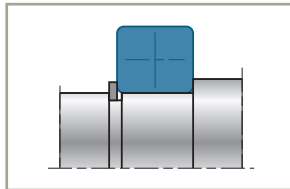

Easy and fast to fit, occupies little space.

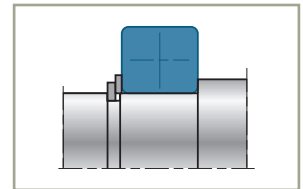

A thrust washer must be installed between the inner ring and the snap ring if axial load is high.

Bearing retention (continued)

Adjusting ring

Reserved for shaft ends.

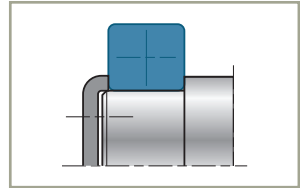

Press fit ring

Preferential direction of axial thrust (→).

The ring has to be destroyed to remove the bearing.

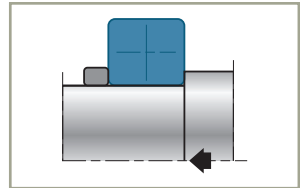

Sleeve

Preferential direction of axial thrust (→).

Does not need precise machining of the shaft.

Above all used for spherical roller bearings.

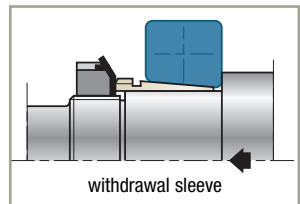
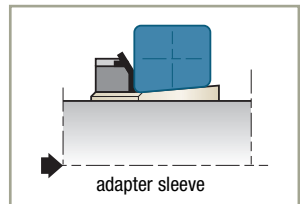

■ Outer ring

Cap

Necessary gap between cap and face of casing.

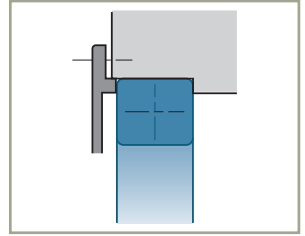

Snap ring

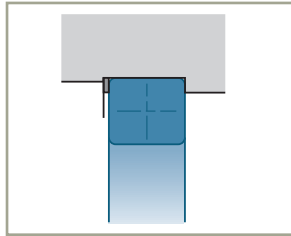

Easy and quick to mount, occupies little space.

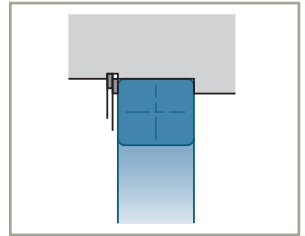

A thrust washer must be installed between the outer ring and the snap ring if axial load is high.

Note : the snap ring (with or without a thrust washer) can replace a shoulder.

Snap ring built in the bearing

(type NR bearing)

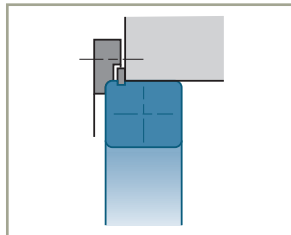

Necessary gap between the cap and the face of the housing.

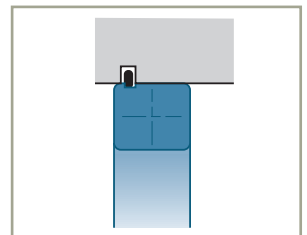

In the particular case where the housing is in two parts, the ring can be installed between the two parts.

Bearing seats

Bearing tolerances

Under the action of the radial load, one of the two rings of a rotating bearing tends to turn. To avoid wearing the seat, this relative displacement must be prevented by having an appropriate fit. The fit of the other ring will allow axial displacement on the seat (adjustment, thermal expansion).

■ Standard precision bearing tolerances

Inner ring

Deviation with respect to the nominal bore

Outer ring

Deviation with respect to the nominal diameter

Bore d	All bearings except tapered roller bearings Δd_{mp} (μm)		Tapered roller bearings Δd_{mp} (μm)	
	max.	min.	max.	min.
2,5 <d≤ 10	0	-8		
10 <d≤ 18	0	-8	0	-12
18 <d≤ 30	0	-10	0	-12
30 <d≤ 50	0	-12	0	-12
50 <d≤ 80	0	-15	0	-15
80 <d≤ 120	0	-20	0	-20
120 <d≤ 180	0	-25	0	-25
180 <d≤ 250	0	-30	0	-30
250 <d≤ 315	0	-35	0	-35
315 <d≤ 400	0	-40	0	-40

Outside diameter D	All bearings except tapered roller bearings ΔD_{mp} (μm)		Tapered roller bearings ΔD_{mp} (μm)	
	max.	min.	max.	min.
6 <D≤ 18	0	-8		
18 <D≤ 30	0	-9	0	-12
30 <D≤ 50	0	-11	0	-14
50 <D≤ 80	0	-13	0	-16
80 <D≤ 120	0	-15	0	-18
120 <D≤ 150	0	-18	0	-20
150 <D≤ 180	0	-25	0	-25
180 <D≤ 250	0	-30	0	-30
250 <D≤ 315	0	-35	0	-35
315 <D≤ 400	0	-40	0	-40
400 <D≤ 500	0	-45	0	-45
500 <D≤ 630	0	-50	0	-50

Other precision classes, see page 23.

Shaft and housing seat tolerances

The shafts are generally machined in tolerances of quality 6 or sometimes 5. The housings, which are more difficult to machine, are usually in quality 7 or sometimes 6 tolerances.

■ **Fundamental tolerance values (taken from Standard ISO 286).**

Diameter mm	Quality		
	5	6	7
>3 to 6	5	8	12
>6 to 10	6	9	15
>10 to 18	8	11	18
>18 to 30	9	13	21
>30 to 50	11	16	25
>50 to 80	13	19	30
>80 to 120	15	22	35
>120 to 180	18	25	40
>180 to 250	20	29	46
>250 to 315	23	32	52
>315 to 400	25	36	57
>400 to 500	27	40	63

In certain cases, the shape and taper defects in the chosen tolerance interval are unacceptable because they are detrimental to correct bearing operation. In such cases a smaller tolerance interval must be adopted.

Bearing seats (continued)

Recommended fits

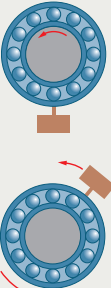
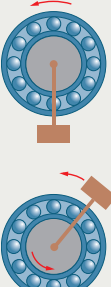
Analysis of rotation	Retention principle	Shaft			Housing		
		Applications	Recommended fits	Examples	Applications	Recommended fits	Examples
The load turns with respect to the outer ring 	Inner ring press fitted on shaft	Normal loads $P < C / 5$	j6 / k6	Electric motors Machine tool spindles Pumps Fans Speed reducers	General case	H7 / J7	Electric motors of moderate power Pulleys Machine-tool spindles Transmissions
		High loads $P > C / 5$	m6 / p6	Traction motors Large speed reducer, compressors			
The load turns with respect to the inner ring 	Outer ring press fitted in housing	General case	g6 / h6	Idler pulleys Tensioners Wheels	Normal loads $P < C / 5$	M7 / N7	Idler pulleys Tensioners Wheels
		Ring floats on its seat	f6 / g6	Axial displacement required (expansion or adjustment)			
Other cases		Purely axial loads	h6 / j6	Bearings and thrust bearings	Purely axial loads	G7 / H7	Bearings and thrust bearings
		Adapter sleeves	h9	Transmissions Agricultural Equipment			

Different choices can be made to take into account various construction and operating factors: for example, if an assembly is subject to vibration and impact, tighter fits must be considered.

Moreover, the type of mounting and the installation procedure can demand different fits. For example, the fit adopted for light alloy housings is usually tighter than those normally specified, to compensate for the differential thermal expansion.

The following tables illustrate the fits used most frequently in the mounting of bearings.
 Example for an SNR 6305 ball bearing (25x62x17)

■ Bearing/housing fit

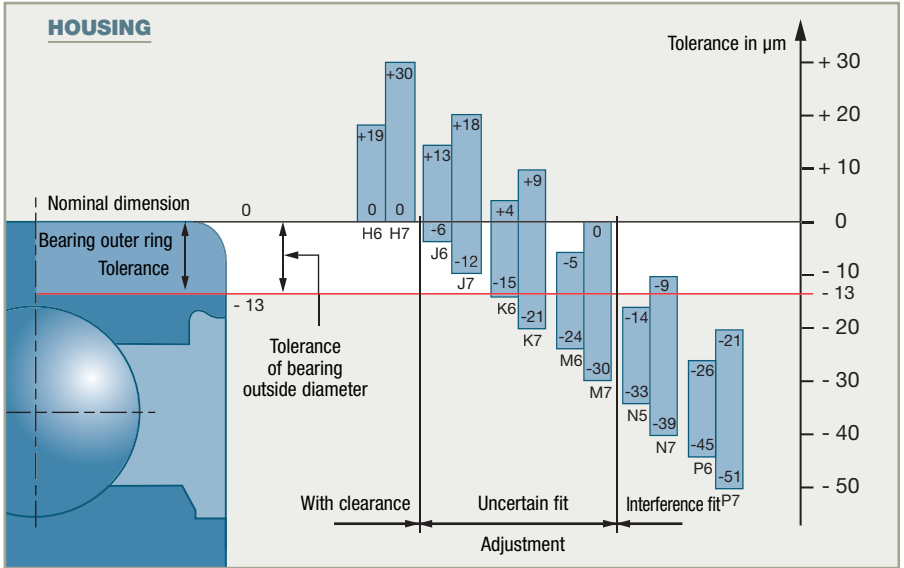

■ Shaft/bearing fit

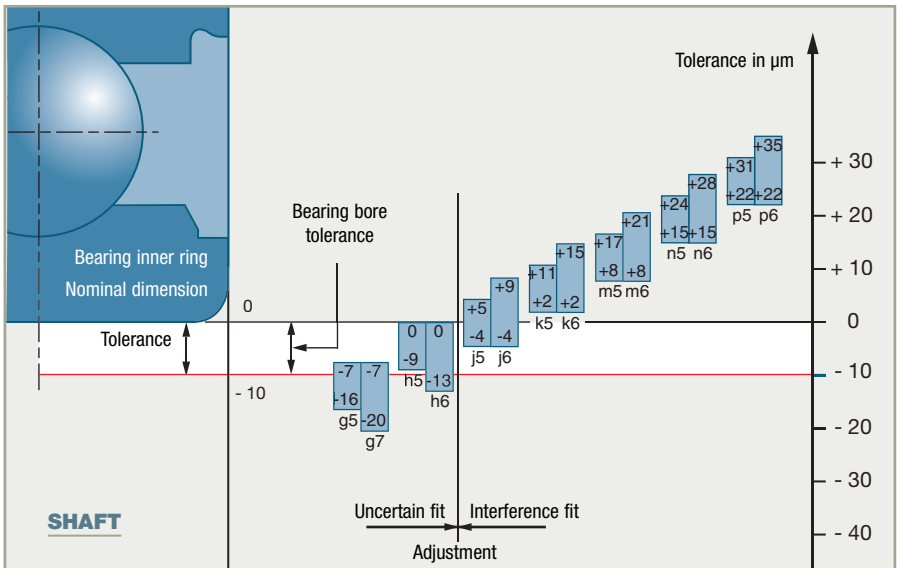

Bearing seats *(continued)*

Value of tolerances and fits

The tables on the following pages indicate:

- the tolerance (in μm) on the bore or outside diameter of the bearing (Standard ISO 492)
- the tolerance (in μm) on the seat diameter according to the chosen fit. (Standard ISO 286)
- the differences (in μm) between the respective diameters of the bearing and its seat:
 - Theoretical values calculated from the extreme bearing and seat tolerance values
 - Mean values
 - Probable values calculated using the Gauss distribution law. (with a probability of 99.7%) from the formula:

$$\text{Probable tol.} = [(\text{Bearing tol.})^2 + (\text{Seat tol.})^2]^{1/2}$$

These tables concern all types of bearings except tapered roller bearings. For tapered roller bearings, use the same calculation procedure but with their specific tolerances.



In practice, one generally only considers the probable tolerance (the risks of error being limited to 0.3%) to determine a realistic value for the probable clearance tolerance of a bearing after fitting.

■ Example

SNR 6305 bearing (25 mm bore).

Fit on shaft k5.

	Tolerance		Mean value	Tolerance interval
	mini	maxi		
Bearing bore	-10	0	-5	10
Shaft tolerance	+2	+11	+6.5	9

- theoretical mean interference = $-(\text{shaft mean val.} - \text{bearing mean val.}) = -[6,5 - (-5)] = -11,5$
- theoretical max. interference = $-(\text{shaft max. val.} - \text{bearing min. val.}) = -[11 - (-10)] = -21$
- theoretical min. interference = $-(\text{shaft min. val.} - \text{bearing max. val.}) = -(2 - 0) = -2$
- probable tolerance = $[(\text{bearing tol. interval})^2 + (\text{shaft tol. interval})^2]^{1/2} = (10^2 + 9^2)^{1/2} = 13$
- probable max. interference = theoretical mean interference - probable tolerance / 2
 $= -11,5 - 6,5 = -18$
- probable min. interference = theoretical mean interference + probable tolerance / 2
 $= -11,5 + 6,5 = -5$

■ Fits on shaft for normal class bearings (all bearings except tapered roller bearings)

SHAFT																		
Nominal diameter of shaft (mm)	Bearing bore tolerance (µm)	Fits	f5	f6	g5	g6	h5	h6	j5	j6								
3 <math>< d_s \leq 6</math>	-8 0	Shaft tolerances in µm	-15	-10	-10	-9	-4	-12	-4	-5	0	-8	0	1	+4	-1	+7	
		Mean	+8.5	+10	+10	-2.5	-4	+1.5	+0	-6	+5.5	-5.5	-1	-5.5	-10	-1.5	-7	
		Probable difference in diameters	+13	+4	+15.5	+4.5	+7	-2	+9.5	-1.5	+3	-6	+5.5	-5.5	-1	-10	-1.5	-12.5
6 <math>< d_s \leq 10</math>	-8 0	Shaft tolerances in µm	-19	-13	-22	-13	-11	-5	-14	-5	-6	0	-9	0	-2	+4	-2	+7
		Mean	+12	+13.5	+4	+4	+5.5	-1	+0.5	0	-5	-6.5	-5.5	0	-10	-0.5	-12.5	
		Probable difference in diameters	+17	+7	+19.5	+7.5	+9	-1	+11.5	-0.5	+4	-6	+6.5	-5.5	0	-10	-0.5	-12.5
10 <math>< d_s \leq 18</math>	-8 0	Shaft tolerances in µm	-24	-16	-27	-16	-14	-6	-17	-6	-8	0	-11	0	-3	+5	-3	+8
		Mean	+16	+17.5	+6	+6	+7.5	0	+1.5	0	-5	-5	-5	-5	-5	-5	-5	-6.5
		Probable difference in diameters	+21.5	+10.5	+24.5	+10.5	+11.5	+0.5	+14.5	+0.5	+5.5	-5.5	+8.5	-5.5	+0.5	-10.5	+0.5	-13.5
18 <math>< d_s \leq 30</math>	-10 0	Shaft tolerances in µm	-29	-20	-33	-20	-16	-7	-20	-7	-9	0	-13	0	-4	+5	-4	+9
		Mean	+19.5	+21.5	+6.5	+6.5	+8.5	-0.5	+1.5	0	-5.5	-5.5	-5.5	-5.5	-5.5	-5.5	-5.5	-7.5
		Probable difference in diameters	+26	+13	+30	+13	+13	0	+17	0	+6	-7	+10	-7	+1	-12	+1	-16
30 <math>< d_s \leq 50</math>	-12 0	Shaft tolerances in µm	-36	-25	-41	-25	-20	-9	-25	-9	-11	0	-16	0	-5	+6	-5	+11
		Mean	+24.5	+27	+8.5	+8.5	+11	-0.5	+2	0	-6.5	-6.5	-6.5	-6.5	-6.5	-6.5	-6.5	-9
		Probable difference in diameters	+32.5	+16.5	+37	+17	+16.5	+0.5	+21	+1	+7.5	-8.5	+12	-8	+1.5	-14.5	+1	-19
50 <math>< d_s \leq 65</math>	-15 0	Shaft tolerances in µm	-43	-30	-49	-30	-23	-10	-29	-10	-13	0	-19	0	-7	+6	-7	+12
		Mean	+29	+32	+9	+9	+12	-1	+2	0	-7	-7	+2	0	-7	-7	-7	-10
		Probable difference in diameters	+39	+19	+44	+20	+19	-1	+24	0	+9	-11	+14	-10	+3	-17	+2	-22
65 <math>< d_s \leq 80</math>	-15 0	Shaft tolerances in µm	-43	-30	-49	-30	-23	-10	-29	-10	-13	0	-19	0	-7	+6	-7	+12
		Mean	+29	+32	+9	+9	+12	-1	+2	0	-7	-7	+2	0	-7	-7	-7	-10
		Probable difference in diameters	+39	+19	+44	+20	+19	-1	+24	0	+9	-11	+14	-10	+3	-17	+2	-22
80 <math>< d_s \leq 100</math>	-20 0	Shaft tolerances in µm	-51	-36	-58	-36	-27	-12	-34	-12	-15	0	-22	0	-9	+6	-9	+13
		Mean	+33.5	+37	+9.5	+9.5	+13	-2.5	+1	0	-8.5	-8.5	-8.5	-8.5	-8.5	-8.5	-8.5	-12
		Probable difference in diameters	+46	+21	+52	+22	+22	-3	+28	-2	+10	-15	+16	-14	+4	-21	+3	-27
100 <math>< d_s \leq 120</math>	-20 0	Shaft tolerances in µm	-51	-36	-58	-36	-27	-12	-34	-12	-15	0	-22	0	-9	+6	-9	+13
		Mean	+33.5	+37	+9.5	+9.5	+13	-2.5	+1	0	-8.5	-8.5	-8.5	-8.5	-8.5	-8.5	-8.5	-12
		Probable difference in diameters	+46	+21	+52	+22	+22	-3	+28	-2	+10	-15	+16	-14	+4	-21	+3	-27
120 <math>< d_s \leq 140</math>	-25 0	Shaft tolerances in µm	-61	-43	-68	-43	-32	-14	-39	-14	-18	0	-25	0	-11	+7	-11	+14
		Mean	+39.5	+43	+10.5	+10.5	+14	-3.5	0	-10.5	-10.5	-10.5	-10.5	-10.5	-10.5	-10.5	-10.5	-14
		Probable difference in diameters	+55	+24	+60.5	+25.5	+26	-5	+31.5	-3.5	+12	-19	+17.5	-17.5	+5	-26	+4	-32
140 <math>< d_s \leq 160</math>	-25 0	Shaft tolerances in µm	-61	-43	-68	-43	-32	-14	-39	-14	-18	0	-25	0	-11	+7	-11	+14
		Mean	+39.5	+43	+10.5	+10.5	+14	-3.5	0	-10.5	-10.5	-10.5	-10.5	-10.5	-10.5	-10.5	-10.5	-14
		Probable difference in diameters	+55	+24	+60.5	+25.5	+26	-5	+31.5	+3.5	+12	-19	+17.5	-17.5	+5	-26	+4	-32
160 <math>< d_s \leq 180</math>	-25 0	Shaft tolerances in µm	-61	-43	-68	-43	-32	-14	-39	-14	-18	0	-25	0	-11	+7	-11	+14
		Mean	+39.5	+43	+10.5	+10.5	+14	-3.5	0	-10.5	-10.5	-10.5	-10.5	-10.5	-10.5	-10.5	-10.5	-14
		Probable difference in diameters	+55	+24	+60.5	+25.5	+26	-5	+31.5	-3.5	+12	-19	+17.5	-17.5	+5	-26	+4	-32
180 <math>< d_s \leq 200</math>	-30 0	Shaft tolerances in µm	-70	-50	-79	-50	-35	-15	-44	-15	-20	0	-29	0	-13	+7	-13	+16
		Mean	+45	+49.5	+10	+10	+14.5	-5	-0.5	-12	-12	-16.5	-16.5	-16.5	-16.5	-16.5	-16.5	-17.5
		Probable difference in diameters	+63	+27	+70.5	+28.5	+28	-8	+35.5	-6.5	+13	-23	+20.5	-21.5	+6	-30	+4.5	-37.5
200 <math>< d_s \leq 225</math>	-30 0	Shaft tolerances in µm	-70	-50	-79	-50	-35	-15	-44	-15	-20	0	-29	0	-13	+7	-13	+16
		Mean	+45	+49.5	+10	+10	+14.5	-5	-0.5	-12	-12	-16.5	-16.5	-16.5	-16.5	-16.5	-16.5	-17.5
		Probable difference in diameters	+63	+27	+70.5	+28.5	+28	-8	+35.5	-6.5	+13	-23	+20.5	-21.5	+6	-30	+4.5	-37.5
225 <math>< d_s \leq 250</math>	-30 0	Shaft tolerances in µm	-70	-50	-79	-50	-35	-15	-44	-15	-20	0	-29	0	-13	+7	-13	+16
		Mean	+45	+49.5	+10	+10	+14.5	-5	-0.5	-12	-12	-16.5	-16.5	-16.5	-16.5	-16.5	-16.5	-17.5
		Probable difference in diameters	+63	+27	+70.5	+28.5	+28	-8	+35.5	-6.5	+13	-23	+20.5	-21.5	+6	-30	+4.5	-37.5
250 <math>< d_s \leq 280</math>	-35 0	Shaft tolerances in µm	-79	-56	-88	-56	-40	-17	-49	-17	-23	0	-32	0	-16	+7	-16	+16
		Mean	+50	+54.5	+11	+11	+15.5	-6	-1.5	-13	-13	-17.5	-17.5	-17.5	-17.5	-17.5	-17.5	-18.5
		Probable difference in diameters	+71	+29	+78	+31	+32	-10	+39	-8	+15	-27	+22	-25	+8	-34	+6	-41
280 <math>< d_s \leq 315</math>	-35 0	Shaft tolerances in µm	-79	-56	-88	-56	-40	-17	-49	-17	-23	0	-32	0	-16	+7	-16	+16
		Mean	+50	+54.5	+11	+11	+15.5	-6	-1.5	-13	-13	-17.5	-17.5	-17.5	-17.5	-17.5	-17.5	-18.5
		Probable difference in diameters	+71	+29	+78	+31	+32	-10	+39	-8	+15	-27	+22	-25	+8	-34	+6	-41
315 <math>< d_s \leq 400</math>	-40 0	Shaft tolerances in µm	-87	-62	-98	-62	-43	-18	-54	-18	-25	0	-36	0	-18	+7	-18	+18
		Mean	+57	+62.5	+13	+13	+18.5	-5	-0.5	-12	-12	-16.5	-16.5	-16.5	-16.5	-16.5	-16.5	-17.5
		Probable difference in diameters	+79	+35	+88	+37	+35	-9	+44	-7	+17	-27	+26	-25	+10	-34	+8	-43
400 <math>< d_s \leq 500</math>	-45 0	Shaft tolerances in µm	-95	-68	-108	-68	-47	-20	-60	-20	-27	0	-40	0	-20	+7	-20	+20
		Mean	+64	+70.5	+16	+16	+22.5	-4	-2.5	-11	-11	-17.5	-17.5	-17.5	-17.5	-17.5	-17.5	-18.5
		Probable difference in diameters	+86	+42	+97	+44	+38	-6	+49	-4	+18	-26	+29	-24	+11	-33	+9	-44
500 <math>< d_s \leq 630</math>	-50 0	Shaft tolerances in µm		-120	-76			-66	-22	-32	0	-44	0					
		Mean		+80.5	+26.5			+55	-2	+11.5	-25	+33	-24					
		Probable difference in diameters		+109	+52			+55	-2	+22	-25	+33	-24					
630 <math>< d_s \leq 800</math>	-75 0	Shaft tolerances in µm		-130	-80			-74	-24	-36	0	-50	0					
		Mean		+87.5	+31.5			+62	+1	+26	-25	+38	-23					
		Probable difference in diameters		+118	+57			+62	+1	+26	-25	+38	-23					

1. A negative value denotes an interference fit and a positive value a loose fit
2. The probable fit values are calculated on the assumption that the statistical distribution of the dimensions within the tolerances follows a "normal" law (Gauss distribution law)
3. Bearing tolerances and fits: values in microns (µm)
4. ▼ The most common fits

■ Fits on shaft for normal class bearings (all bearings except tapered roller bearings)

SHAFT											
Nominal diameter of shaft (mm)	Bearing bore tolerance (µm)	Fits	k5	k6	m5	m6	n5	n6	p5	p6	
			+1 +6	+1 +9	+4 +9	+4 +12	+8 +13	+8 +16	+12 +17	+12 +20	
3 <d _s 6	-8 0	Shaft tolerances in µm	+1 +6	+1 +9	+4 +9	+4 +12	+8 +13	+8 +16	+12 +17	+12 +20	
		Mean	-7.5	-9	-10.5	-12	-14.5	-16	-18.5	-20	
		Probable difference in diameters	-3 -12	-3.5 -14.5	-6 -15	-6.5 -17.5	-10 -19	-10.5 -21.5	-14 -23	-14.5 -25.5	
6 <d _s 10	-8 0	Shaft tolerances in µm	+1 +7	+1 +10	+8 +12	+6 +15	+10 +16	+10 +19	+15 +21	+15 +24	
		Mean	-8	-9.5	-13	-14.5	-17	-18.5	-22	-23.5	
		Probable difference in diameters	-3 -13	-3.5 -15.5	-8 -18	-8.5 -20.5	-12 -22	-12.5 -24.5	-17 -27	-17.5 -29.5	
10 <d _s 18	-8 0	Shaft tolerances in µm	+1 +9	+1 +12	+7 +15	+7 +18	+12 +20	+12 +23	+18 +26	+18 +29	
		Mean	-9	-10.5	-15	-16.5	-20	-21.5	-26	-27.5	
		Probable difference in diameters	-3.5 -14.5	-3.5 -17.5	-9.5 -20.5	-9.5 -23.5	-14.5 -25.5	-14.5 -28.5	-20.5 -31.5	-20.5 -34.5	
18 <d _s 30	-10 0	Shaft tolerances in µm	+2 +11	+2 +15	+8 +17	+8 +21	+15 +24	+15 +28	+22 +31	+22 +35	
		Mean	-11.5	-13.5	-17.5	-19.5	-24.5	-26.5	-31.5	-33.5	
		Probable difference in diameters	-5 -18	-5 -22	-11 -24	-11 -28	-18 -31	-18 -35	-25 -38	-25 -42	
30 <d _s 50	-12 0	Shaft tolerances in µm	+2 +13	+2 +18	+9 +20	+9 +25	+17 +28	+17 +33	+26 +37	+26 +42	
		Mean	-13.5	-16	-20.5	-23	-28.5	-31	-37.5	-40	
		Probable difference in diameters	-5.5 -21.5	-6 -26	-12.5 -28.5	-13 -33	-20.5 -36.5	-21 -41	-29.5 -45.5	-30 -50	
50 <d _s 65	-15 0	Shaft tolerances in µm	+2 +15	+2 +21	+11 +24	+11 +30	+20 +33	+20 +39	+32 +45	+32 +51	
		Mean	-16	-19	-25	-28	-34	-37	-46	-49	
		Probable difference in diameters	-6 -26	-7 -31	-15 -35	-16 -40	-24 -44	-25 -49	-36 -56	-37 -61	
65 <d _s 80	-15 0	Shaft tolerances in µm	+2 +15	+2 +21	+11 +24	+11 +30	+20 +33	+20 +39	+32 +45	+32 +51	
		Mean	-16	-19	-25	-28	-34	-37	-46	-49	
		Probable difference in diameters	-6 -26	-7 -31	-15 -35	-16 -40	-24 -44	-25 -49	-36 -56	-37 -61	
80 <d _s 100	-20 0	Shaft tolerances in µm	+3 +18	+3 +25	+13 +28	+13 +35	+23 +38	+23 +45	+37 +52	+37 +59	
		Mean	-20.5	-24	-30.5	-34	-40.5	-44	-54.5	-58	
		Probable difference in diameters	-8 -33	-9 -39	-18 -43	-19 -49	-28 -53	-29 -59	-42 -67	-43 -73	
100 <d _s 120	-20 0	Shaft tolerances in µm	+3 +18	+3 +25	+13 +28	+13 +35	+23 +38	+23 +45	+37 +52	+37 +59	
		Mean	-20.5	-24	-30.5	-34	-40.5	-44	-54.5	-58	
		Probable difference in diameters	-8 -33	-9 -39	-18 -43	-19 -49	-28 -53	-29 -59	-42 -67	-43 -73	
120 <d _s 140	-25 0	Shaft tolerances in µm	+3 +21	+3 +28	+15 +33	+15 +40	+27 +45	+27 +52	+43 +61	+43 +68	
		Mean	-24.5	-28	-36.5	-40	-48.5	-52	-64.5	-68	
		Probable difference in diameters	-9 -40	-10.5 -45.5	-21 -52	-22.5 -57.5	-33 -64	-34.5 -69.5	-49 -80	-50.5 -85.5	
140 <d _s 160	-25 0	Shaft tolerances in µm	+3 +21	+3 +28	+15 +33	+15 +40	+27 +45	+27 +52	+43 +61	+43 +68	
		Mean	-24.5	-28	-36.5	-40	-48.5	-52	-64.5	-68	
		Probable difference in diameters	-9 -40	-10.5 -45.5	-21 -52	-22.5 -57.5	-33 -64	-34.5 -69.5	-49 -80	-50.5 -85.5	
160 <d _s 180	-25 0	Shaft tolerances in µm	+3 +21	+3 +28	+15 +33	+15 +40	+27 +45	+27 +52	+43 +61	+43 +68	
		Mean	-24.5	-28	-36.5	-40	-48.5	-52	-64.5	-68	
		Probable difference in diameters	-9 -40	-10.5 -45.5	-21 -52	-22.5 -57.5	-33 -64	-34.5 -69.5	-49 -80	-50.5 -85.5	
180 <d _s 200	-30 0	Shaft tolerances in µm	+4 +24	+4 +33	+17 +37	+17 +46	+31 +51	+31 +60	+50 +70	+50 +79	
		Mean	-29	-33.5	-42	-46.5	-56	-60.5	-75	-79.5	
		Probable difference in diameters	-11 -47	-12.5 -54.5	-24 -60	-25.5 -67.5	-38 -74	-39.5 -81.5	-57 -93	-58.5 -100.5	
200 <d _s 225	-30 0	Shaft tolerances in µm	+4 +24	+4 +33	+17 +37	+17 +46	+31 +51	+31 +60	+50 +70	+50 +79	
		Mean	-29	-33.5	-42	-46.5	-56	-60.5	-75	-79.5	
		Probable difference in diameters	-11 -47	-12.5 -54.5	-24 -60	-25.5 -67.5	-38 -74	-39.5 -81.5	-57 -93	-58.5 -100.5	
225 <d _s 250	-30 0	Shaft tolerances in µm	+4 +24	+4 +33	+17 +37	+17 +46	+31 +51	+31 +60	+50 +70	+50 +79	
		Mean	-29	-33.5	-42	-46.5	-56	-60.5	-75	-79.5	
		Probable difference in diameters	-11 -47	-12.5 -54.5	-24 -60	-25.5 -67.5	-38 -74	-39.5 -81.5	-57 -93	-58.5 -100.5	
250 <d _s 280	-35 0	Shaft tolerances in µm	+4 +27	+4 +36	+20 +43	+20 +52	+34 +57	+34 +66	+56 +79	+56 +88	
		Mean	-33	-37.5	-49	-53.5	-63	-67.5	-85	-89.5	
		Probable difference in diameters	-12 -54	-14 -61	-28 -70	-30 -77	-42 -84	-44 -91	-64 -106	-66 -113	
280 <d _s 315	-35 0	Shaft tolerances in µm	+4 +27	+4 +36	+20 +43	+20 +52	+34 +57	+34 +66	+56 +79	+56 +88	
		Mean	-33	-37.5	-49	-53.5	-63	-67.5	-85	-89.5	
		Probable difference in diameters	-12 -54	-14 -61	-28 -70	-30 -77	-42 -84	-44 -91	-64 -106	-66 -113	
315 <d _s 400	-40 0	Shaft tolerances in µm	+4 +29	+4 +40	+21 +46	+21 +57	+37 +62	+37 +73	+62 +87	+62 +98	
		Mean	-34	-39.5	-51	-56.5	-67	-72.5	-92	-97.5	
		Probable difference in diameters	-12 -56	-14 -65	-29 -73	-31 -82	-45 -89	-47 -98	-70 -114	-72 -123	
400 <d _s 500	-45 0	Shaft tolerances in µm	+5 +32	+5 +45	+23 +50	+23 +63	+40 +67	+40 +80	+68 +95	+68 +108	
		Mean	-36	-42.5	-54	-60.5	-71	-77.5	-99	-105.5	
		Probable difference in diameters	-14 -58	-16 -69	-32 -76	-34 -87	-49 -93	-51 -104	-77 -121	-79 -132	
500 <d _s 630	-50 0	Shaft tolerances in µm		0 +44		+26 +70		+44 +88		+78 +122	
		Mean		-39.5		-85.5		-117.5		-171.5	
		Probable difference in diameters		-11 -68		-37 -94		-55 -112		-89 -146	
630 <d _s 800	-75 0	Shaft tolerances in µm		0 +50		+30 +80		+50 +100		+88 +138	
		Mean		-42.5		-72.5		-92.5		-130.5	
		Probable difference in diameters		-12 -73		-42 -103		-62 -123		-100 -161	

1. A negative value denotes an interference fit and a positive value a loose fit
2. The probable fit values are calculated on the assumption that the statistical distribution of the dimensions within the tolerances follows a "normal" law (Gauss distribution law)
3. Bearing tolerances and fits: values in microns (µm)
4. ▼ The most common fits



Bearing retention and clearances

■ Fits in the housings for normal class bearings (all bearings except tapered roller bearings)

HOUSING											
Nominal diameter of housing (mm)	Tolerance on outside diameter (µm)	▼									
		Fits	G6	G7	H6	H7	J6	J7	K6	K7	
10 <D> 18	-8 0	Housing tolerance	+6 +17	+6 +24	0 +11	0 +18	-5 +6	-8 +10	-9 +2	-12 +6	
		Mean	+15.5	+19	+9.5	+13	+4.5	+5	+0.5	+1	
		Probable difference in diameters	+22.5 +8.5	+29 +9	+16.5 +2.5	+23 +3	+11.5 -2.5	+15 -5	+7.5 -6.5	+11 -9	
18 <D> 30	-9 0	Housing tolerance	+7 +20	+7 +28	0 +13	0 +21	-5 +6	-8 +9	+12	-11 +2	-15 +6
		Mean	+18	+22	+11	+15	+5	+6	0	+6	0
		Probable difference in diameters	+26 +10	+33.5 +10.5	+19 +3	+26.5 +3.5	+14 -2	+17.5 -5.5	+8 -8	-11.5 -11.5	
30 <D> 50	-11 0	Housing tolerance	+9 +25	+9 +34	0 +16	0 +25	-6 +10	-11 +14	-13 +3	-18 +7	
		Mean	+22.5	+27	+13.5	+18	+7.5	+7	+0.5	0	
		Probable difference in diameters	+32 +13	+40.5 +13.5	+23 +4	+31.5 +4.5	+17 -2	+20.5 -6.5	+10 -9	+13.5 -13.5	
50 <D> 65	-13 0	Housing tolerance	+10 +29	+10 +40	0 +19	0 +30	-6 +13	-12 +18	-15 +4	-21 +9	
		Mean	+26	+31.5	+16	+21.5	+10	+9.5	+1	+0.5	
		Probable difference in diameters	+37.5 +14.5	+48 +15	+27.5 +4.5	+38 +5	+21.5 -1.5	+26 -7	+12.5 -10.5	+17 -16	
65 <D> 80	-13 0	Housing tolerance	+10 +29	+10 +40	0 +19	0 +30	-6 +13	-12 +18	-15 +4	-21 +9	
		Mean	+26	+31.5	+16	+21.5	+10	+9.5	+1	+0.5	
		Probable difference in diameters	+37.5 +14.5	+48 +15	+27.5 +4.5	+38 +5	+21.5 -1.5	+26 -7	+12.5 -10.5	+17 -16	
80 <D> 100	-15 0	Housing tolerance	+12 +34	+12 +47	0 +22	0 +35	-6 +16	-13 +22	-18 +4	-25 +10	
		Mean	+30.5	+37	+18.5	+25	+12.5	+12	+0.5	0	
		Probable difference in diameters	+44 +17	+56 +18	+32 +5	+44 +6	+26 -1	+31 -7	+14 -13	+19 -19	
100 <D> 120	-15 0	Housing tolerance	+12 +34	+12 +47	0 +22	0 +35	-6 +16	-13 +22	-18 +4	-25 +10	
		Mean	+30.5	+37	+18.5	+25	+12.5	+12	+0.5	0	
		Probable difference in diameters	+44 +17	+56 +18	+32 +5	+44 +6	+26 -1	+31 -7	+14 -13	+19 -19	
120 <D> 140	-18 0	Housing tolerance	+14 +39	+14 +54	0 +25	0 +40	-7 +18	-14 +26	-21 +4	-28 +12	
		Mean	+35.5	+43	+21.5	+29	+14.5	+15	+0.5	+1	
		Probable difference in diameters	+51 +20	+65 +21	+37 +6	+51 +7	+30 -1	+37 -7	+16 -15	+23 -21	
140 <D> 150	-18 0	Housing tolerance	+14 +39	+14 +54	0 +25	0 +40	-7 +18	-14 +26	-21 +4	-28 +12	
		Mean	+35.5	+43	+21.5	+29	+14.5	+15	+0.5	+1	
		Probable difference in diameters	+51 +20	+65 +21	+37 +6	+51 +7	+30 -1	+37 -7	+16 -15	+23 -21	
150 <D> 160	-25 0	Housing tolerance	+14 +39	+14 +54	0 +25	0 +40	-7 +18	-14 +26	-21 +4	-28 +12	
		Mean	+39	+46.5	+25	+32.5	+18	+18.5	+4	+4.5	
		Probable difference in diameters	+56.5 +21.5	+70 +23	+42.5 +7.5	+56 +9	+35.5 +0.5	+42 -5	+21.5 -13.5	+28 -19	
160 <D> 180	-25 0	Housing tolerance	+14 +39	+14 +54	0 +25	0 +40	-7 +18	-14 +26	-21 +4	-28 +12	
		Mean	+39	+46.5	+25	+32.5	+18	+18.5	+4	+4.5	
		Probable difference in diameters	+56.5 +21.5	+70 +23	+42.5 +7.5	+56 +9	+35.5 +0.5	+42 -5	+21.5 -13.5	+28 -19	
180 <D> 200	-30 0	Housing tolerance	+15 +44	+15 +61	0 +29	0 +46	-7 +22	-16 +30	-24 +5	-33 +13	
		Mean	+44.5	+53	+29.5	+38	+22.5	+22	+5.5	+5	
		Probable difference in diameters	+65.5 +23.5	+80.5 +25.5	+50.5 +2.5	+65.5 +10.5	+43.5 -1.5	+49.5 -5.5	+26.5 -15.5	+32.5 -22.5	
200 <D> 225	-30 0	Housing tolerance	+15 +44	+15 +61	0 +29	0 +46	-7 +22	-16 +30	-24 +5	-33 +13	
		Mean	+44.5	+53	+29.5	+38	+22.5	+22	+5.5	+5	
		Probable difference in diameters	+65.5 +23.5	+80.5 +25.5	+50.5 +8.5	+65.5 +10.5	+43.5 +1.5	+49.5 -5.5	+26.5 -15.5	+32.5 -22.5	
225 <D> 250	-30 0	Housing tolerance	+15 +44	+15 +61	0 +29	0 +46	-7 +22	-16 +30	-24 +5	-33 +13	
		Mean	+44.5	+53	+29.5	+38	+22.5	+22	+5.5	+5	
		Probable difference in diameters	+65.5 +23.5	+80.5 +25.5	+50.5 +8.5	+65.5 +10.5	+43.5 +1.5	+49.5 -5.5	+26.5 -15.5	+32.5 -22.5	
250 <D> 280	-35 0	Housing tolerance	+17 +49	+17 +69	0 +32	0 +52	-7 +25	-16 +36	-27 +5	-36 +16	
		Mean	+50.5	+60.5	+33.5	+43.5	+26.5	+27.5	+6.5	+7.5	
		Probable difference in diameters	+74 +27	+92 +29	+57 +10	+75 +12	+50 +3	+59 -4	+30 -17	+39 -24	
280 <D> 315	-35 0	Housing tolerance	+17 +49	+17 +69	0 +32	0 +52	-7 +25	-16 +36	-27 +5	-36 +16	
		Mean	+50.5	+60.5	+33.5	+43.5	+26.5	+27.5	+6.5	+7.5	
		Probable difference in diameters	+74 +27	+92 +29	+57 +10	+75 +12	+50 +3	+59 -4	+30 -17	+39 -24	
315 <D> 400	-40 0	Housing tolerance	+18 +54	+18 +75	0 +36	0 +57	-7 +29	-18 +39	-29 +7	-40 +17	
		Mean	+53.5	+64	+36.5	+46	+28.5	+28	+6.5	+6	
		Probable difference in diameters	+79 +28	+97 +31	+61 +10	+79 +13	+54 +3	+61 -5	+32 -19	+39 -27	
400 <D> 500	-45 0	Housing tolerance	+20 +60	+20 +83	0 +40	0 +63	-7 +33	-20 +43	-32 +8	-45 +18	
		Mean	+57.5	+69	+37.5	+49	+30.5	+20	+5.5	+4	
		Probable difference in diameters	+84 +31	+105 +33	+64 +11	+85 +13	+57 +4	+7 -35	+32 -21	+40 -32	
500 <D> 630	-50 0	Housing tolerance	+22 +66	+22 +92	0 +44	0 +70			-44	0	-70
		Mean	+61.5	+74.5	+39.5	+52.5			-4.5	-17.5	
		Probable difference in diameters	+90 +33	+114 +35	+68 +11	+92 +13			+24 -33	+22 -57	
630 <D> 800	-75 0	Housing tolerance	+24 +74	+24 +104	0 +50	0 +80			-50	0	-80
		Mean	+66.5	+81.5	+42.5	+57.5			-7.5	-22.5	
		Probable difference in diameters	+97 +36	+125 +38	+73 +12	+101 +14			+23 -38	+21 -66	
800 <D> 1000	-100 0	Housing tolerance	+26 +82	+26 +116	0 +56	0 +90			-56	0	-90
		Mean	+71.5	+88.5	+45.5	+62.5			-10.5	-27.5	
		Probable difference in diameters	+105 +38	+137 +40	+79 +12	+111 +14			+23 -44	+21 -76	

1. A negative value denotes an interference fit and a positive value a loose fit
2. The probable fit values are calculated on the assumption that the statistical distribution of the dimensions within the tolerances follows a "normal" law (Gauss distribution law)
3. Bearing tolerances and fits: values in microns (µm)
4. ▼ The most common fits

■ Fits in the housings for normal class bearings (all bearings except tapered roller bearings)

HOUSING		▼																	
Nominal diameter of housing (mm)	Tolerance on outside diameter (μm)	Fits	M6	M7	N6	N7	P6	P7	R6	R7									
10 <D _s 18	-8 0	Housing tolerance	-15	-4	-18	0	-20	-9	-23	-5	-26	-15	-29	-11	-31	-20	-34	-16	
		Mean	-5.5	-5	-10.5	-5	-10.5	-5	-10.5	-5	-10.5	-5	-16	-16	-21.5	-21.5	-21.5	-21.5	-21.5
		Probable difference in diameters	+1.5 -12.5	+5 -15	-3.5 -17.5	0	0	-20	-9	-5.5 -23.5	-6	-26	-14.5 -28.5	-11	-31	-11	-31	-11	-31
18 <D _s 30	-9 0	Housing tolerance	-17	-4	-21	0	-24	-11	-28	-7	-31	-18	-35	-14	-37	-24	-41	-20	
		Mean	-6	-6	-13	-13	-13	-20	-20	-20	-20	-20	-20	-20	-26	-26	-26	-26	-26
		Probable difference in diameters	+2 -14	+5.5 -17.5	-5 -21	-5	-21	-1.5 -24.5	-12	-28	-8.5	-31.5	-18	-34	-14.5	-37.5	-14.5	-37.5	-14.5
30 <D _s 50	-11 0	Housing tolerance	-20	-4	-25	0	-28	-12	-33	-8	-37	-21	-42	-17	-45	-29	-50	-25	
		Mean	-6.5	-7	-14.5	-15	-15	-23.5	-24	-24	-24	-24	-24	-24	-31.5	-31.5	-31.5	-31.5	
		Probable difference in diameters	+3 -16	+6.5 -20.5	-5 -24	-5	-24	-1.5 -28.5	-14	-33	-10.5	-37.5	-22	-41	-18.5	-45.5	-18.5	-45.5	-18.5
50 <D _s 65	-13 0	Housing tolerance	-24	-5	-30	0	-33	-14	-39	-9	-45	-26	-51	-21	-54	-35	-60	-30	
		Mean	-8	-8.5	-17	-17.5	-17.5	-29	-29	-29	-29.5	-29.5	-29.5	-29.5	-38.5	-38.5	-38.5	-38.5	
		Probable difference in diameters	+3.5 -19.5	+8 -25	-5.5 -28.5	-1	-34	-17.5	-40.5	-13	-46	-26.5	-49.5	-22	-52	-22	-52	-22	-52
65 <D _s 80	-13 0	Housing tolerance	-24	-5	-30	0	-33	-14	-39	-9	-45	-26	-51	-21	-56	-37	-62	-32	
		Mean	-8	-8.5	-17	-17.5	-17.5	-29	-29	-29	-29.5	-29.5	-29.5	-29.5	-38.5	-38.5	-38.5	-38.5	
		Probable difference in diameters	+3.5 -19.5	+8 -25	-5.5 -28.5	-1	-34	-17.5	-40.5	-13	-46	-26.5	-49.5	-22	-52	-22	-52	-22	-52
80 <D _s 100	-15 0	Housing tolerance	-28	-6	-35	0	-38	-16	-45	-10	-52	-30	-59	-24	-66	-44	-73	-38	
		Mean	-9.5	-10	-19.5	-19.5	-19.5	-33	-33	-33	-33.5	-33.5	-33.5	-33.5	-47.5	-47.5	-47.5	-47.5	
		Probable difference in diameters	+4 -23	+9 -29	-6 -33	-1	-39	-20	-47	-15	-53	-34	-61	-29	-67	-29	-67	-29	-67
100 <D _s 120	-15 0	Housing tolerance	-28	-6	-35	0	-38	-16	-45	-10	-52	-30	-59	-24	-66	-47	-76	-41	
		Mean	-9.5	-10	-19.5	-19.5	-19.5	-33	-33	-33	-33.5	-33.5	-33.5	-33.5	-50.5	-50.5	-50.5	-50.5	
		Probable difference in diameters	+4 -23	+9 -29	-6 -33	-1	-39	-20	-47	-15	-53	-34	-61	-29	-64	-32	-70	-32	-70
120 <D _s 140	-18 0	Housing tolerance	-33	-8	-40	0	-45	-20	-52	-12	-61	-36	-68	-28	-81	-56	-88	-48	
		Mean	-11.5	-11	-23.5	-23	-23	-39.5	-39	-39	-39.5	-39.5	-39.5	-39.5	-59.5	-59	-59	-59	
		Probable difference in diameters	+4 -27	+11 -33	-8 -39	-1	-45	-24	-55	-17	-61	-44	-75	-37	-81	-37	-81	-37	-81
140 <D _s 150	-18 0	Housing tolerance	-33	-8	-40	0	-45	-20	-52	-12	-61	-36	-68	-28	-83	-58	-90	-50	
		Mean	-11.5	-11	-23.5	-23	-23	-39.5	-39	-39	-39.5	-39.5	-39.5	-39.5	-61.5	-61	-61	-61	
		Probable difference in diameters	+4 -27	+11 -33	-8 -39	-1	-45	-24	-55	-17	-61	-46	-77	-39	-83	-39	-83	-39	-83
150 <D _s 160	-25 0	Housing tolerance	-33	-8	-40	0	-45	-20	-52	-12	-61	-36	-68	-28	-83	-58	-90	-50	
		Mean	-8	-7.5	-20	-19.5	-19.5	-36	-36	-36	-36.5	-36.5	-36.5	-36.5	-58	-58	-58	-58	
		Probable difference in diameters	+9.5 -25.5	+16 -31	-2.5 -37.5	+4	-43	-18.5	-53.5	-12	-59	-40.5	-75.5	-34	-87.5	-34	-87.5	-34	-87.5
160 <D _s 180	-25 0	Housing tolerance	-33	-8	-40	0	-45	-20	-52	-12	-61	-36	-68	-28	-86	-61	-93	-53	
		Mean	-8	-7.5	-20	-19.5	-19.5	-36	-36	-36	-36.5	-36.5	-36.5	-36.5	-61	-60.5	-60.5	-60.5	
		Probable difference in diameters	+9.5 -25.5	+16 -31	-2.5 -37.5	+4	-43	-18.5	-53.5	-12	-59	-43.5	-78.5	-37	-84	-37	-84	-37	-84
180 <D _s 200	-30 0	Housing tolerance	-37	-8	-46	0	-51	-22	-60	-14	-70	-41	-79	-33	-97	-68	-106	-60	
		Mean	-7.5	-8	-21.5	-22	-22	-40.5	-41	-41	-41	-41	-41	-41	-67.5	-68	-68	-68	
		Probable difference in diameters	+13.5 -28.5	+19.5 -35.5	-0.5 -42.5	+5.5	-49.5	-19.5	-61.5	-13.5	-68.5	-46.5	-88.5	-35	-95.5	-35	-95.5	-35	-95.5
200 <D _s 225	-30 0	Housing tolerance	-37	-8	-46	0	-51	-22	-60	-14	-70	-41	-79	-33	-100	-71	-109	-63	
		Mean	-7.5	-8	-21.5	-22	-22	-40.5	-41	-41	-41	-41	-41	-41	-70.5	-71	-71	-71	
		Probable difference in diameters	+13.5 -28.5	+19.5 -35.5	-0.5 -42.5	+5.5	-49.5	-19.5	-61.5	-13.5	-68.5	-49.5	-91.5	-35	-98.5	-35	-98.5	-35	-98.5
225 <D _s 250	-30 0	Housing tolerance	-37	-8	-46	0	-51	-22	-60	-14	-70	-41	-79	-33	-104	-75	-113	-67	
		Mean	-7.5	-8	-21.5	-22	-22	-40.5	-41	-41	-41	-41	-41	-41	-74.5	-75	-75	-75	
		Probable difference in diameters	+13.5 -28.5	+19.5 -35.5	-0.5 -42.5	+5.5	-49.5	-19.5	-61.5	-13.5	-68.5	-53.5	-95.5	-35	-102.5	-35	-102.5	-35	-102.5
250 <D _s 280	-35 0	Housing tolerance	-41	-9	-52	0	-57	-25	-66	-14	-79	-47	-88	-36	-117	-85	-126	-74	
		Mean	-7.5	-8.5	-23.5	-22.5	-22.5	-45.5	-45.5	-45.5	-44.5	-44.5	-44.5	-44.5	-83.5	-82.5	-82.5	-82.5	
		Probable difference in diameters	+16 -31	+23 -40	0 -47	+9	-54	-22	-69	-13	-76	-60	-107	-51	-114	-51	-114	-51	-114
280 <D _s 315	-35 0	Housing tolerance	-41	-9	-52	0	-57	-25	-66	-14	-79	-47	-88	-36	-121	-89	-130	-78	
		Mean	-7.5	-8.5	-23.5	-22.5	-22.5	-45.5	-45.5	-45.5	-44.5	-44.5	-44.5	-44.5	-87.5	-86.5	-86.5	-86.5	
		Probable difference in diameters	+16 -31	+23 -40	0 -47	+9	-54	-22	-69	-13	-76	-64	-111	-51	-118	-51	-118	-51	-118
315 <D _s 400	-40 0	Housing tolerance	-46	-10	-57	0	-62	-26	-73	-16	-87	-51	-98	-41	-119	-95	-128	-85	
		Mean	-10.5	-11	-26.5	-27	-27	-46	-46	-46	-46	-46	-46	-46	-92	-92	-92	-92	
		Probable difference in diameters	+15 -36	+22 -44	-1	-52	+6	-60	-26	-77	-19	-85	-61	-108	-45	-108	-45	-108	-45
400 <D _s 500	-45 0	Housing tolerance	-50	-10	-63	0	-67	-27	-80	-17	-95	-55	-108	-45	-128	-95	-137	-85	
		Mean	-12.5	-14	-29.5	-31	-31	-57.5	-55	-55	-55	-55	-55	-55	-110.5	-110.5	-110.5	-110.5	
		Probable difference in diameters	+14 -39	+22 -50	-3 -56	+5	-67	-31	-84	-23	-95	-75	-127.5	-45	-127.5	-45	-127.5	-45	-127.5
500 <D _s 630	-50 0	Housing tolerance	-70	-26	-96	-26	-88	-44	-114	-44	-122	-78	-148	-78	-168	-108	-188	-108	
		Mean	-30.5	-43.5	-48.5	-61.5	-61.5	-82.5	-82.5	-82.5	-82.5	-82.5	-82.5	-82.5	-108.5	-108.5	-108.5	-108.5	
		Probable difference in diameters	-2 -59	-4 -83	-20	-77	-22	-101	-54	-111	-54	-111	-56	-135	-56	-135	-56	-135	
630 <D _s 800	-75 0	Housing tolerance	-80	-30	-110	-30	-100	-50	-130	-50	-138	-88	-168	-88	-198	-128	-228	-128	
		Mean	-37.5	-52.5	-57.5	-72.5	-72.5	-95.5	-95.5	-95.5	-95.5	-95.5	-95.5	-95.5	-127.5	-127.5	-127.5	-127.5	
		Probable difference in diameters	-7 -68	-9 -96	-27	-88	-29	-116	-65	-126	-67	-154	-87	-182	-87	-182	-87	-182	
800 <D _s 1000	-100 0	Housing tolerance	-90	-34	-124	-34	-112	-56	-146	-56	-156	-100	-190	-100	-220	-140	-270	-140	
		Mean	-44.5	-61.5	-66.5	-83.5	-83.5	-106.5	-106.5	-106.5	-106.5	-106.5	-106.5	-106.5	-132.5	-132.5	-132.5	-132.5	
		Probable difference in diameters	-11 -78	-13 -110	-33	-100	-35	-132	-77	-144	-79	-176	-107	-204	-107	-204	-107	-204	

1. A negative value denotes an interference fit and a positive value a loose fit

2. The probable fit values are calculated on the assumption that the statistical distribution of the dimensions within the tolerances follows a "normal" law (Gauss distribution law)

3. Bearing tolerances and fits: values in microns (μm)

4. ▼ The most common fits

Bearing seats *(continued)*

Geometry and surface conditions of shaft and housing seats

■ Shoulder diameters and fillet radii

A contact surface is necessary between the ring and the shoulder to ensure good retention of the bearing.

► The sections in this catalog of Standard Bearings specifies:

- the shaft and housing shoulder diameters (D_1 and d_3)
- the shoulder fillet radii (r_1)

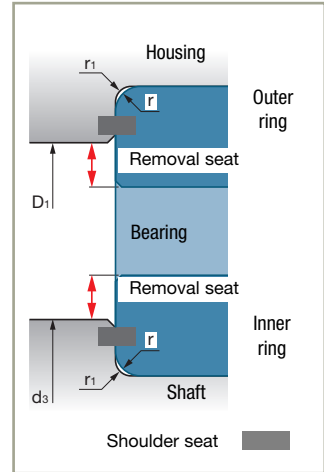

If for construction reasons the shoulder seat dimension cannot be respected, provide an extra spacer between the bearing ring and the shoulder.

The fillet radii between the shoulders and the ring seats must be less than the corner radius of the corresponding ring. The values are indicated in the chapter corresponding to each family.

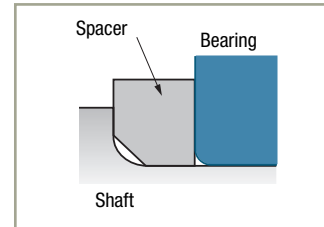

► Fillet greater than the bearing corner radius

When a shaft is subjected to high bending stresses, the shoulder must be given a fillet radius that is greater than that of the bearing.

In this case, a chamfered spacer is placed between the shaft shoulder and the bearing ring to give a sufficiently large contact surface.

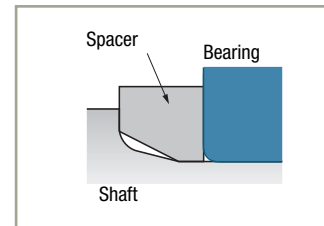

► Special corner radius

If the bearing must be fixed close to the shoulder, a special corner radius can be machined on its inner ring.

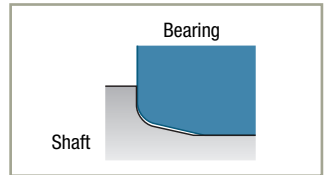

► Elimination of the fillet radius

If there are no particular requirements for the shaft profile and strength, it is possible to make an undercut that facilitates grinding of the seats and ensures in all cases the best contact between the ring and the shoulder.

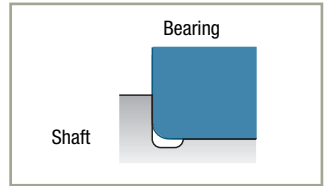

■ Removal seat

The bearing is usually removed using an extraction tool whose claws clamp on the part of the ring that protrudes beyond the shoulder. See page 140.

If the mounting configuration does not leave a sufficiently large removal seat, notches can be cut in the shoulder or a washer can be placed between the shoulder and the bearing inner ring.

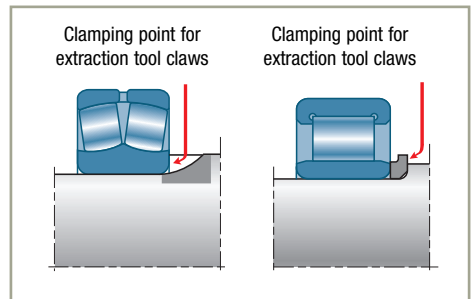

Bearing seats (continued)

Tolerances and surface conditions of shaft and housing seats

Shaft

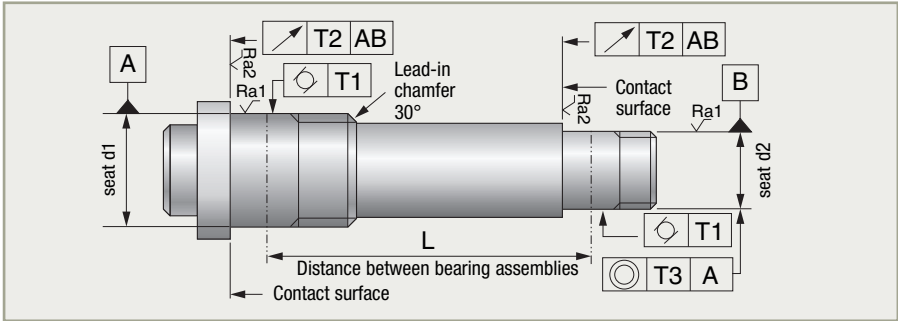

Nominal inside diameter of bearing d (mm)	Tolerances in μm				
	T1	T2	T3	Ra1	Ra2
10 $d \le 18$	3	11	1.5 L L in mm	≤ 1	≤ 2
18 $d \le 30$	4	13			
30 $d \le 50$	4	16			
50 $d \le 80$	5	19			
80 $d \le 120$	6	22			
120 d	8	25			

Housing

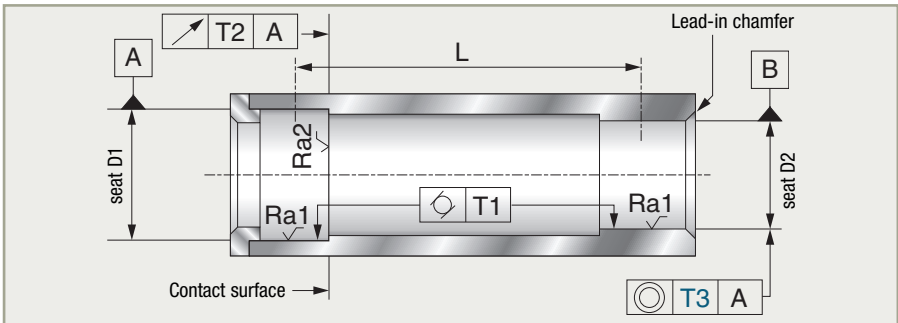

Nominal inside diameter of bearing d (mm)	Tolerances in μm				
	T1	T2	T3	Ra1	Ra2
18 $D \le 30$	6	21	2 L L in mm	≤ 2	≤ 4
30 $D \le 50$	7	25			
50 $D \le 80$	8	30			
80 $D \le 120$	10	35			
120 D	12	40			

Radial clearance of radial contact bearings

Residual radial clearance: definition, calculation

The residual radial clearance is the radial clearance of the bearing after installation or in operation. It depends on the internal radial clearance, the fits, the temperatures and the deformations.

The residual clearance must be sufficient to ensure satisfactory operating conditions.

To calculate the residual clearance, it is given an algebraic value. When this value is positive, there is a mechanical clearance, when it is negative there is a preload.

The operating residual clearance of the bearing has a direct influence on its service life and general performance (precision of rotation, noise, etc.). It must therefore be determined as accurately as possible.

→ Ratio of interference effect on clearance

When two parts are assembled together with an interference fit, each part displays a change in diameter after assembly.

The ratio is:

$$t_i \text{ or } t_e = \frac{\text{reduction of internal radial clearance}}{\text{interference on inner or outer ring}}$$

The ratio is calculated using the standard material strength formulae which introduce the cross-sectional dimensions of the parts concerned, the E modulus of elasticity and their respective Poisson ratios.

We propose the following approximate ratios for the most common cases:

Bearing element	Seat	Ratio
Inner ring	Solid shaft	$t_i \approx 0.8$
	Hollow shaft	$t_i \approx 0.6$
Outer ring	Steel or cast-iron housing	$t_e \approx 0.7$
	Light alloy housing	$t_e \approx 0.5$

SNR can provide a precise calculation of the clearance reduction.

Radial clearance of radial contact bearings *(continued)*

→ Residual clearance after fitting: J_{rm}

$$J_{rm} = J_o - t_i \cdot S_i - t_e \cdot S_e$$

J_o	Internal radial clearance
S_i	Interference of the inner ring on the shaft
t_i	Inner ring/shaft effect ratio
S_e	Interference of the outer ring in its housing
t_e	Outer ring/housing effect ratio

■ Required approximate mean residual clearance after fitting (in mm)

Ball bearings	$J_{rm} = 10^{-3} d^{1/2}$
Cylindrical roller bearings	$J_{rm} = 4 \cdot 10^{-3} d^{1/2}$
Self-aligning ball bearings	$J_{rm} = 2 \cdot 10^{-3} d^{1/2}$
Spherical roller bearings	$J_{rm} = 5 \cdot 10^{-3} d^{1/2}$

■ Example of calculation of residual clearance and its range using the fits tables of page 102.

Bearing 6305 - bore 25 mm - outside diameter 62 mm

- Solid steel shaft: tolerance k5
- Cast-iron housing: tolerance N6

■ Mean residual clearance

The fits tables give:

	min	mean	max
Shaft tolerances	+2		+11
Mean theoretical and probable value S_i		-11.5	
Probable clearance (+) or interference (-)	-5		-18

	min	mean	max
Housing tolerances	-33		+14
Mean theoretical and probable value S_i		-17	
Probable clearance (+) or interference (-)	-5.5		-28.5

Table in previous page gives the respective effect ratios of $t_i = 0.8$ (shaft) and $t_e = 0.7$ (housing).

The mean reduction in clearance is:

$$R_{jm} = (t_i \cdot S_i) + (t_e \cdot S_e)$$

(only valid if $S_i < 0$ and $S_e < 0$)

$$R_{jm} = (0.8 \times -11.5) + (0.7 \times -17) = -21 \mu\text{m}$$

■ The minimum initial clearance value must be greater than the mean reduction in clearance R_{jm}

The table in page 156 of initial clearances for this type of bearing shows that a category 4 clearance is necessary (23 to 41 μm : mean value 32 μm) to have a satisfactory residual clearance after fitting the bearing:

Mean residual clearance:

$$J_{rm} = 32 - 21 = 11 \mu\text{m}$$

The definition of the bearing will therefore be 6305 J40 (C4)

■ Range of residual clearance after fitting

Probable range of interference on the shaft
(difference between extreme values):

$$D_{pci} = 13 \mu\text{m}$$

Probable range of interference in the housing
(difference between extreme values):

$$D_{ppl} = 23 \mu\text{m}$$

Considering the previous effect ratios, the probable ranges on radial clearance are:

$$\begin{aligned} D_{pci} &= D_{pa} \cdot t_i = 13 \mu\text{m} \times 0.8 \\ &= 10.5 \mu\text{m} \\ &\text{for the inner ring} \end{aligned}$$

$$\begin{aligned} D_{pce} &= D_{pl} \cdot t_e = 23 \mu\text{m} \times 0.7 \\ &= 16 \mu\text{m} \\ &\text{for the outer ring} \end{aligned}$$

Range of bearing internal clearance:

$$D_{er} = 41 - 23 = 18 \mu\text{m}$$

According to the laws of probabilities, the range of the residual clearance will be:

$$\begin{aligned} \Delta J_r &= (D_{pci}^2 + D_{pce}^2 + D_{er}^2)^{1/2} \\ &= (10.5^2 + 16^2 + 18^2)^{1/2} = 26 \mu\text{m} \end{aligned}$$

The 6305 bearing with a category 4 clearance mounted with k5 and N6 fits has an operating clearance of:

$$J_f = J_{rm} \pm \Delta J_r / 2 = 11 \pm 13 \mu\text{m}$$

Radial clearance of radial contact bearings *(continued)*

→ Choice of internal clearance as a function of shaft and housing fits

The example on the previous page shows that interference fits on shaft and housing require a bearing with increased clearance.

The table below defines the limit fits for the shaft and housing.

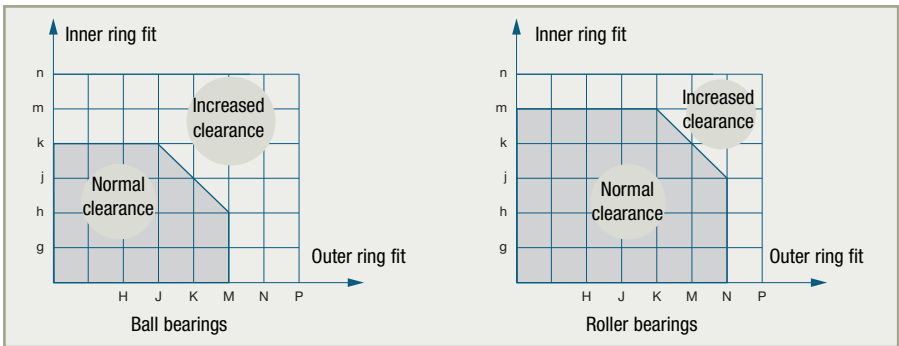

→ Calculation of the residual clearance in operation

The residual clearance in operation is a function of the residual clearance after mounting and the relative temperature differential between shaft and housing.

■ Materials with different coefficients of expansion

Bearing mounted in a light alloy housing.

The difference in the bearing and housing diameters resulting from differential expansion is:

$$\Delta D = (C_2 - C_1) D \cdot \Delta t = 8 \cdot 10^{-6} \cdot D \cdot \Delta t$$

where:

Δt Operating temperature 20°C (68°F)

D Bearing outside diameter

C1 Expansion coefficient of steel = 12×10^{-6} mm/mm/°C

C2 Expansion coefficient of the light alloy housing = 20×10^{-6} mm/mm/°C

The different expansion of the materials will increase the clearance of the outer ring in its housing and can allow it to rotate. This differential expansion must be compensated for by having a tighter fit and using a bearing with increased clearance.

► Example

Choice of housing fit for a 6305 bearing ($D = 62$ mm) mounted in light alloy with an operating temperature of 80°C (176°F).

$$\Delta t = 60^{\circ}\text{C}$$

$$\Delta D = 8 \cdot 10^{-6} \cdot 62 \cdot 60 = 0.030 \text{ mm}$$

With a J7 tolerance, the housing diameter is on average $10 \mu\text{m}$ larger than the bearing diameter.

$$\text{At } 80^{\circ}\text{C, it is } 10 \mu\text{m} + \Delta D = 40 \mu\text{m}$$

See page 101.

This value is too high to secure a good retention of the bearing in the housing. Therefore, choosing a P7 housing tolerance with a mean interference of $30 \mu\text{m}$ will compensate for the effect of differential expansion at 80°C (176°F).

Choosing a P7 tolerance for the outer ring will lead to a reduction in the radial clearance of the bearing equal to:

$$t_e \cdot S_e = 0,5 \cdot 29,5 = 15 \mu\text{m}$$

If the shaft with a k6 tolerance gives a mean interference of $13,5 \mu\text{m}$ on the inner ring, the reduction of the radial clearance due to the inner ring fit is:

$$t_i \cdot S_i = 0,8 \cdot 13,5 = 11 \mu\text{m}$$

The total reduction in the bearing clearance due to fitting is:

$$R_{jm} = t_e \cdot S_e + t_i \cdot S_i = 15 + 11 = 26 \mu\text{m}$$

One therefore chooses a 6305J40/C4 bearing (clearance category 4: mean radial clearance of $32 \mu\text{m}$) to avoid cancelling the clearance during operation at 20°C (68°F) normal temperature.

Radial clearance of radial contact bearings *(continued)*

■ Temperature difference between shaft and housing

Both the shaft and housing are made of steel, but the temperature of the shaft is higher than that of the housing.

The differential expansion between the bearing inner ring and the outer ring will reduce the radial clearance by the value

$$\Delta J = C1 \times (D \cdot \Delta tl - d \cdot \Delta ta)$$

where:

- C1 Expansion coefficient of the steel
- D Bearing outside diameter
- d Bearing bore
- Δta Difference between the running temperature of the shaft and the room temperature (specified at 20°C or 68°F)
- Δtl Difference between the running temperature of the housing and the room temperature (specified at 20°C or 68°F)

► Example

Let us assume that a 6305 bearing (25 x 62) has a residual clearance J_{rm} of 10 μm after fitting at 20°C (68°F).

In operation:

- the temperature of the shaft and the inner ring is 70°C (158°F)
- the temperature of the housing and the outer ring is 50°C (122°F)

The reduction in radial clearance of the bearing is:

$$\Delta J = 12 \cdot 10^{-6} \cdot ((62 \cdot 30) - (25 \cdot 50)) = 7 \mu\text{m}$$

The operating residual radial clearance is:

$$J_{rf} = J_{rm} - \Delta J = 10 \mu\text{m} - 7 \mu\text{m} = 3 \mu\text{m}$$

In this case it is recommended to use a bearing from Group 3 increased clearance.

Axial clearance of angular contact bearings

Axial preload

A preload is a permanent axial force applied to the bearings when they are fitted. It is obtained by the penetration of the inner ring with respect to the outer ring of each bearing from the reference position.

→ Axial penetration and preload

Under load, the rolling element / raceway contact points undergo plastic deformation due to the very high Hertz pressures, giving an axial displacement of one ring in respect to the other. A curve gives the value of the relative displacement of the two rings according to the axial load.

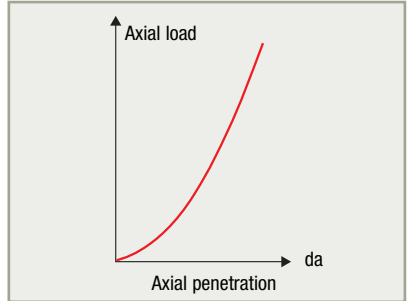

In an assembly with two bearings mounted in opposition, the penetration of one bearing increases the clearance of the other.

In assemblies demanding very high guidance precision (machine-tool spindle, bevel gears, oscillating systems, etc.), a preload must be applied to get rid of the clearance and give optimum rigidity.

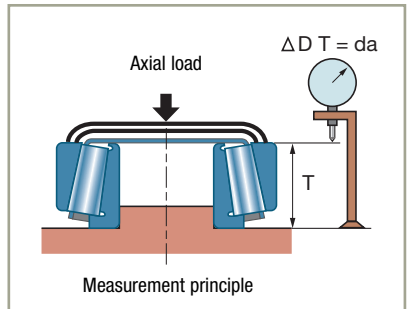

Axial clearance of angular contact bearings *(continued)*

→ Determining the preload

The preload value P is chosen as a function of the mean axial load applied (A_m)

$$P = A_m / 3$$

The two preloaded bearings are studied using the diagram of associated penetration curves.

Without an external axial load, the meeting point (P) corresponds to the applied preload that creates on each bearing a penetration of (d_1) and (d_2) respectively, the total closing of the two bearings being $p = d_1 + d_2$

When an external axial load A is applied to the assembly, each bearing follows its penetration curve. One of the two bearings is subject to an additional penetration (d_a) which reduces the penetration of the opposite bearing by as much

To find the loads F_{a1} and F_{a2} applied to each bearing, the axial load A is positioned between the two curves (points M_1 and M_2).

The axial equilibrium of the shaft is:

$$F_{a1} - F_{a2} = A$$

If A exceeds the value F_d (unseating axial load), the opposite bearing gets an operating axial clearance.

► Remarks:

The diagram of associated penetration curves is modified by any radial loads applied to the bearings.

As any preload influences the resultant loads applied to the bearings, bearing performances must be calculated taking into account the preload value. Consult SNR for these calculations that bring into play the rigidity characteristics. A preloaded assembly has greater friction drag torque than an assembly with clearance. Its lubrication must therefore be studied with the utmost care.

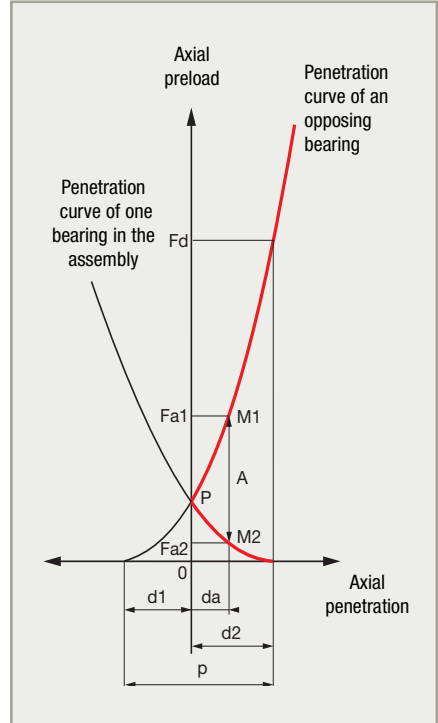

→ Adjustment

The adjustment enables an assembly to be given the predetermined axial clearance or preload. This is done by sliding one ring (inner or outer) of one of the two bearings of the assembly. This ring must therefore be loose fitted on its seat.

If the assembly is to have an axial clearance j_a , it is checked using a dial comparator.

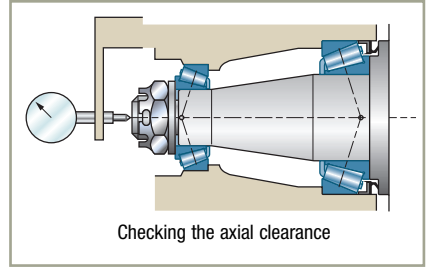

If the assembly is to have a preload value p , one starts with any axial clearance J_a and then the loose bearing ring is moved by the value $J_a + p$. This operation is usually achieved with the shaft nut or by adapting the thickness of the adjustment spacers in the housing. The allowed tolerance on a preloaded setting is tight (about half the one permitted for the axial clearance).

Influence of the temperature on the axial clearance of bearings

→ Modification of clearance on assembly

The axial clearance or preload of a shaft mounted on two angular-contact bearings (ball or tapered roller bearings) can be changed by the operating temperatures.

The assembly opposite schematically illustrates:

- a change in the axial clearance of the assembly due to the difference of axial expansion between the housing and the shaft
- a modification in the outer ring / housing interference that results in a variation of the radial clearance and therefore the axial clearance of the assembly

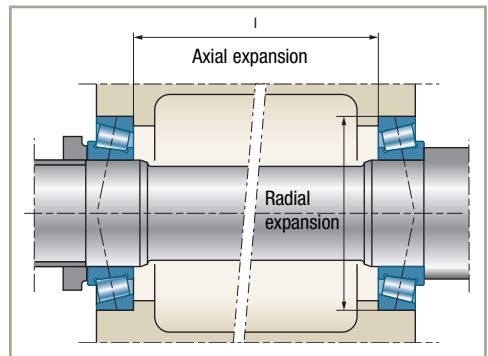

The total change of the axial clearance of the assembly is the algebraic sum of these two variations.

In an O assembly (case shown in the sketch), the two variations are in opposite directions and may cancel each other out. Conversely, in an X assembly the two variations are in the same direction.

Axial clearance of angular contact bearings (continued)

→ Theoretical calculation of the variation in the axial clearance of an assembly

■ Variation due to shaft and housing different axial expansion

$$\Delta Ja_1 = (l \cdot C_2 \cdot \Delta t) - (l \cdot C_1 \cdot \Delta t) = (C_2 - C_1) \cdot l \cdot \Delta t$$

where:

- l** Distance between the bearings
- C1** Expansion coefficient of the shaft
- C2** Expansion coefficient of the housing
- Δt** Difference between the operating temperature and the room temperature (specified at 20°C or 68°F)

■ Variation due to the modification of the outer ring/housing interference

	Bearing 1	Bearing 2
Temperature at which the outer ring/housing interference is cancelled by the expansion of the housing	$\Delta t_{01} = S_1 / ((C_2 - C_1) \cdot D_1)$	$\Delta t_{02} = S_2 / ((C_2 - C_1) \cdot D_2)$
	D_1, D_2 S_1, S_2	Outside diameters of the bearings Diametral interference of the bearings
Variations of interference with temperature	If $\Delta t \leq \Delta t_{01}$: $\Delta S_1 = (C_2 - C_1) \cdot D_1 \cdot \Delta t$ If $\Delta t > \Delta t_{01}$: $\Delta S_1 = S_1$	If $\Delta t \leq \Delta t_{02}$: $\Delta S_2 = (C_2 - C_1) \cdot D_2 \cdot \Delta t$ If $\Delta t > \Delta t_{02}$: $\Delta S_2 = S_2$
Variation of axial clearance due to the modification of the outer ring/housing interference	$\Delta Ja_2 = (K_1 \cdot te_1 \cdot \Delta S_1) + (K_2 \cdot te_2 \cdot \Delta S_2)$ te_1, te_2 : effect ratio of this interference on the radial clearance page 109 K_1, K_2 : transformation coefficients of radial clearance into axial clearance $K_1 = Y_1 / 0.8$ Y_1, Y_2 see page 59	
		$K_2 = Y_2 / 0.8$

■ Total variation in the axial clearance of the assembly

Assembly in X arrangement

$$\Delta Ja = \Delta Ja_2 + \Delta Ja_1$$

Assembly in O arrangement

$$\Delta Ja = \Delta Ja_2 - \Delta Ja_1$$

These calculations enable the initial clearance to be fixed in order to get the desired clearance values in operation.

Example

Take an assembly of two 32 210 tapered roller bearings mounted in an O arrangement in an aluminium housing (P7 fit); operating temperature 80°C (176°F):

- $l = 240 \text{ mm}$
- $D_1 = D_2 = 90 \text{ mm}$
- $C_2 - C_1 = 8 \times 10^{-6} \text{ mm/mm}^\circ\text{C}$
- $Y_1 = Y_2 = 1.43$
- $S_1 = S_2 = 0.0335 \text{ mean value}$
- $\Delta t = 60^\circ\text{C} (140^\circ\text{F})$
- $te_1 = te_2 = 0.5 \text{ see page 109}$

► Variation in axial clearance due to axial expansion ΔJa_1 $\Delta Ja_1 = 8 \cdot 10^{-6} \cdot 240 \cdot 60 = 0.114 \text{ mm}$

► Variation due to the modification in the outer ring/housing interference

	Bearing 1	Bearing 2
Temperature at which the outer ring/housing interference is cancelled by the expansion of the housing	$\Delta t_0 = \Delta t_2 = 0.0335 / (8 \cdot 10^{-6} \cdot 90) = 47^\circ\text{C}$	
Variations of interference with temperature	$\Delta t > \Delta t_0$ and Δt_2 $\Delta S_1 = \Delta S_2 = 0.0335$	
Variation of axial clearance due to the modification in outer ring/housing interference	$\Delta Ja_2 = ((1.43 / 0.8) \cdot 0.5 \cdot 0.0335) + (1.78 \cdot 0.5 \cdot 0.0335) = 0.060$	

► Total variation in the axial clearance of the assembly $\Delta Ja = + 0.060 - 0.114 = -0.054$

The following graphs illustrate the variation in axial clearance of the assembly according to the operating temperature in the X and O assembly arrangements.

Assembly in O arrangement

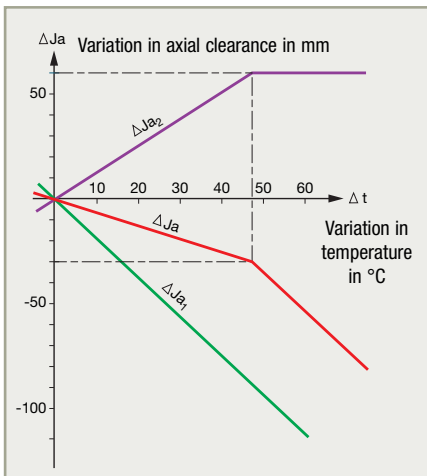

Assembly in X arrangement

